

SINTEZNI PROJEKAT EFEMERNOG POZORIŠTA

SCENSKA ARHITEKTURA, TEHNIKA I DIZAJN

POZ
OU
RKO
SMA
DI
MA

POZORIŠTE U KOMADIMA

OSNOVA 1:100

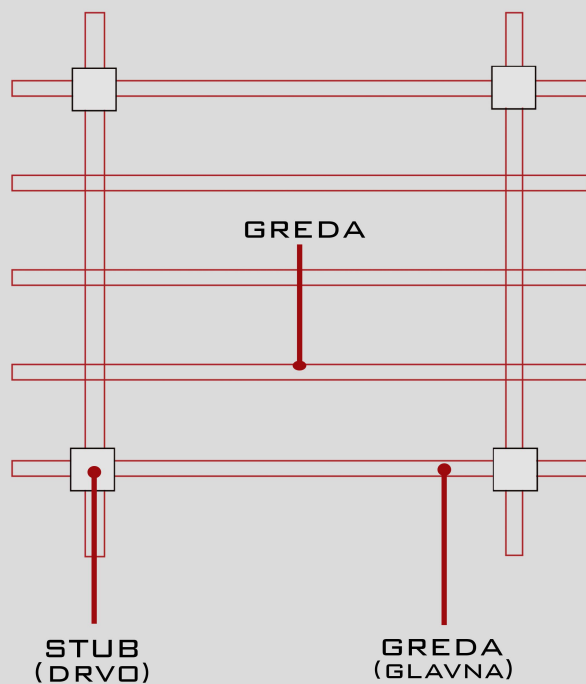
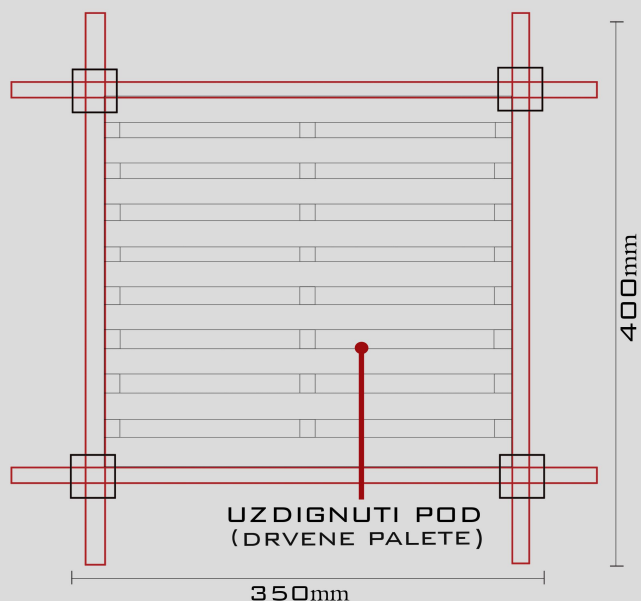

OSNOVA GLEDALIŠTA 1:100

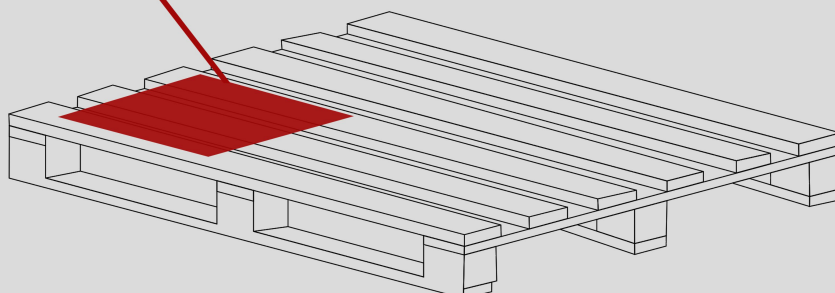
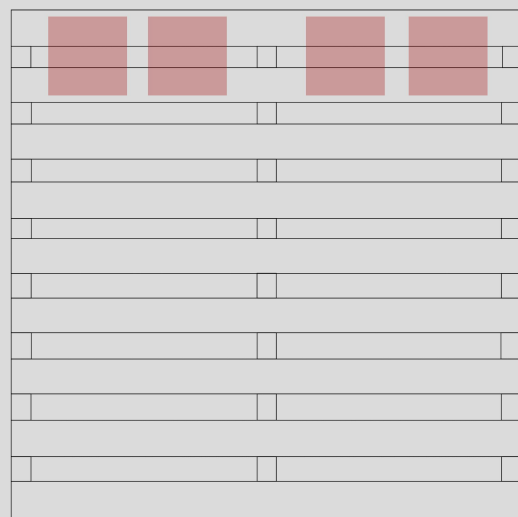
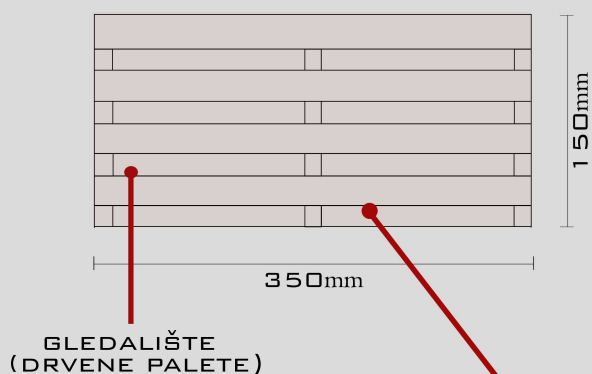

POZORIŠTE U KOMADIMA

1:100

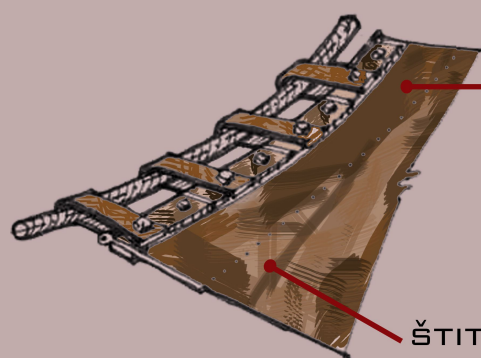
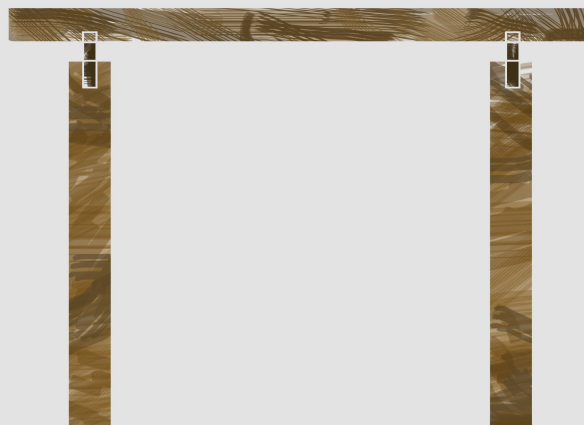
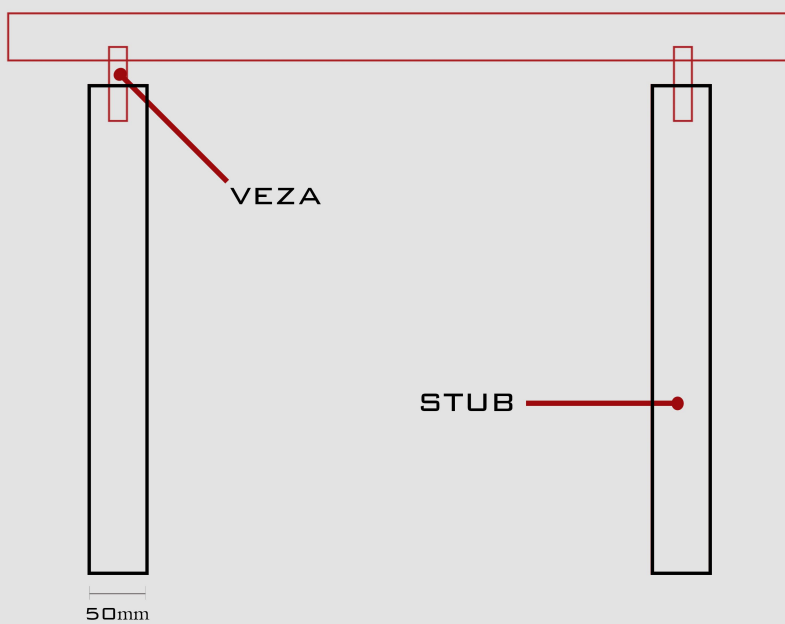
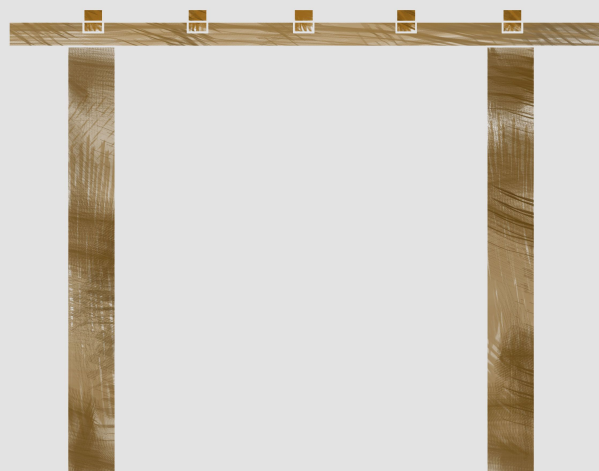
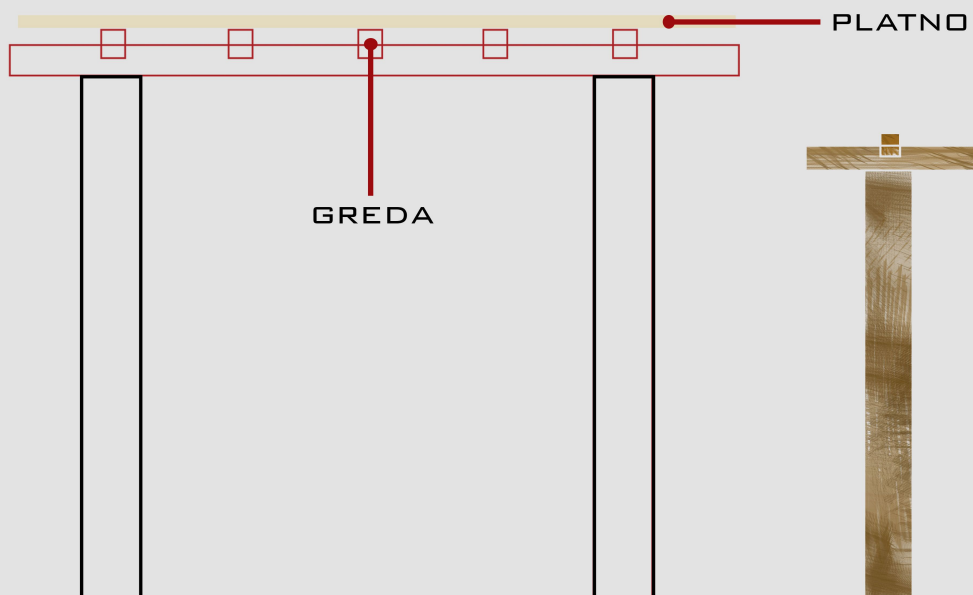

PLATNO ZA PREKRIVANJE
PROSTORA IGRE

ŠTITI OD SUNCA I KIŠE
KOSTISTI SE DA ZAŠTITI ELEMENTE SCENSKE RASVETE

POZORIŠTE U KOMADIMA

SITUACIJA I ODNOS OBJEKTA SA OKOLINOM

- STALNI OBJEKTI
- ZIDOVI KOJI SE KORISTE
- ULAZ ZA POSETIOCE
- ULAZ ZA ZAPOSLENE
- ARHITEKTONSKA RASVETA
- ZONA SCENSKO GLEDALIŠNOG PROSTORA

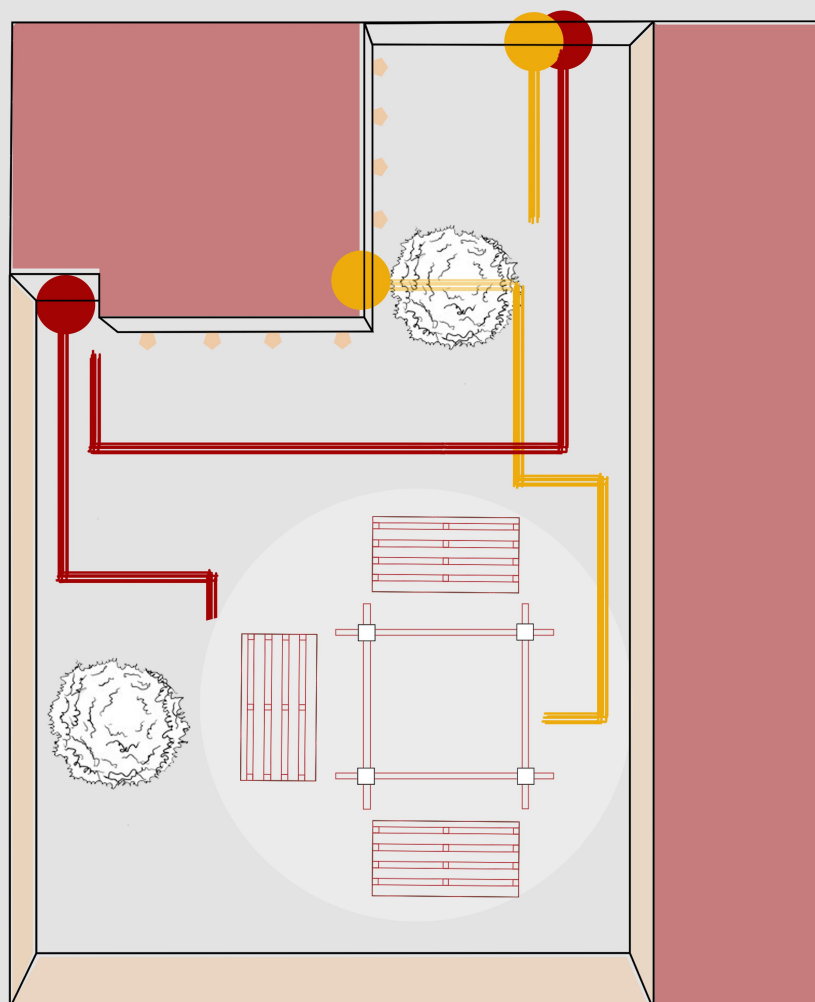

FOTOGRAFIJE MODELA

